



Series 4400

Zetco WaterMarked
2-Piece Stainless Steel
Ball Valve F&F Lockable

FEATURES

MANUFACTURED IN CHINA

STAINLESS STEEL 316

WATERMARKED TO AS 5830.1 LICENCE WM-022438

FULL BORE

BLOW-OUT PROOF STEM

INVESTMENT CASTING

PTFE SEALS

MUST BE OPERATED IN FULLY OPEN OR CLOSED POSITION

ALL VALVES PRESSURE TESTED DURING PRODUCTION

SIZE RANGE: 6MM TO 100MM

PRESSURE AND TEMPERATURE RATINGS

TEMPERATURE RANGE: -20°C TO 150°C

MAXIMUM OPERATING PRESSURE AT NOMINAL TEMPERATURES: 4000 kPa

FOR RATINGS AT SPECIFIC TEMPERATURES REFER TO GRAPH OVERLEAF



WaterMark

IAPMO WM-022438
AS 5830.1

Series 4400

Zetco WaterMarked 2-Piece
Stainless Steel Ball Valve F&F Lockable



DIMENSIONAL AND COMPONENT DIAGRAM

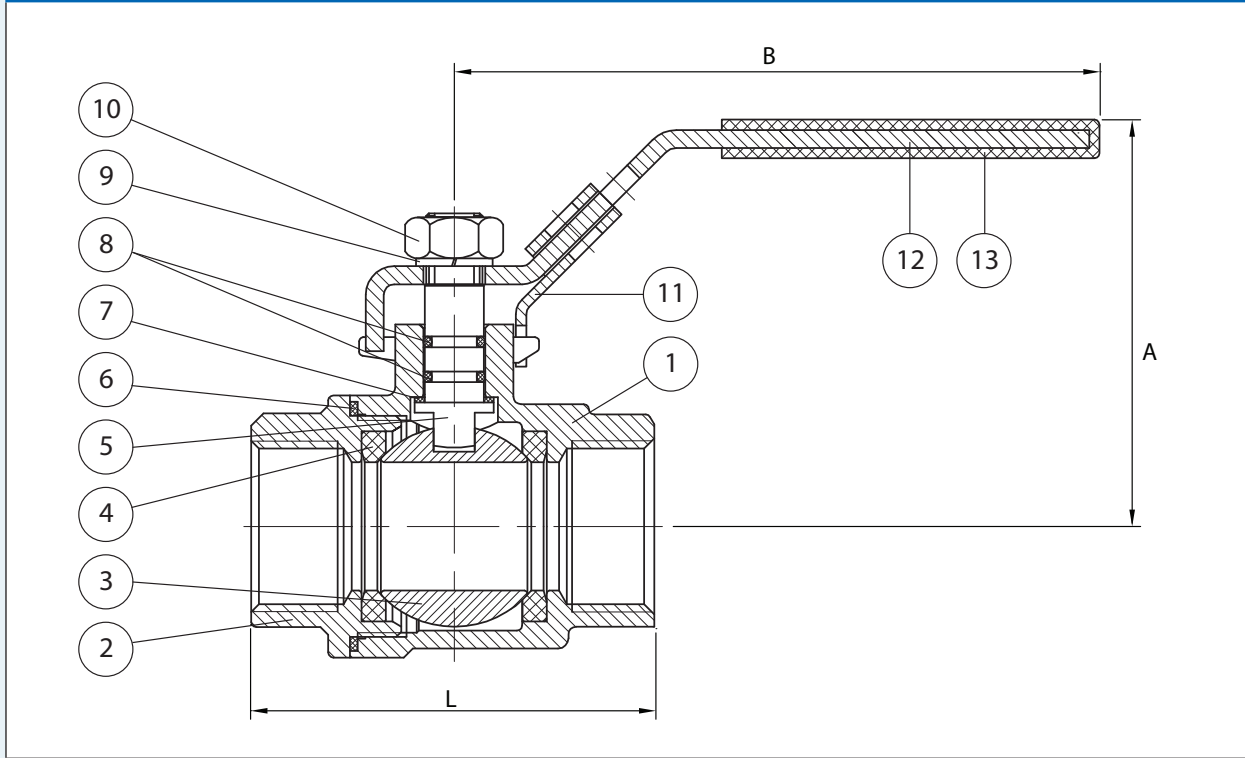

MATERIALS

POS.	PART NAME	MATERIALS
1	BODY	STAINLESS STEEL 316
2	END ADAPTOR	STAINLESS STEEL 316
3	BALL	STAINLESS STEEL 316
4	SEAT	PTFE
5	STEM	STAINLESS STEEL 316
6	GASKET	PTFE
7	THRUST WASHER	PTFE
8	O-RING	VITON®
9	SPRING WASHER	STAINLESS STEEL 304
10	STEM NUT	STAINLESS STEEL 304
11	LOCKING DEVICE	STAINLESS STEEL 304
12	HANDLE	STAINLESS STEEL 304
13	HANDLE SLEEVE	VINYL

DIMENSIONS - mm

Prod. Code	Size	A	B	L	Kv	Wgt kg
4400006	6	56	102	52	5.1	0.240
4400010	10	56	102	52	6.0	0.220
4400015	15	65	123	58	8.6	0.280
4400020	20	68	123	67	21.4	0.460
4400025	25	79	153	81	30.0	0.645
4400032	32	84	153	94	39.4	1.11
4400040	40	94	183	104	68.6	1.41
4400050	50	100	183	126	94.3	2.58
4400065	65	135	246	158	266	5.46
4400080	80	145	246	186	308	8.27
4400100	100	168	350	260	703	16.17

PRESSURE/TEMPERATURE DIAGRAM

